

Mi Vacuum Cleaner G10 Quick Start Guide

1. Do not vacuum liquids. Do not directly clean the vacuum cleaner with water.

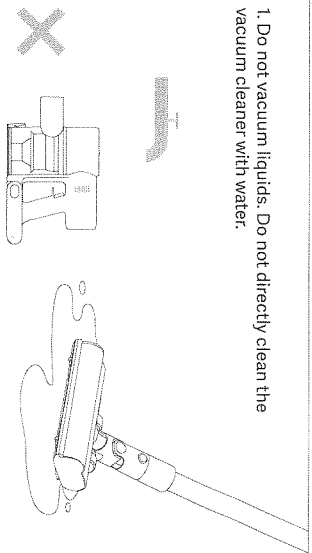

2. Do not vacuum burning or smoking substances, such as unextinguished cigarette butts, or hard or sharp objects like nails.

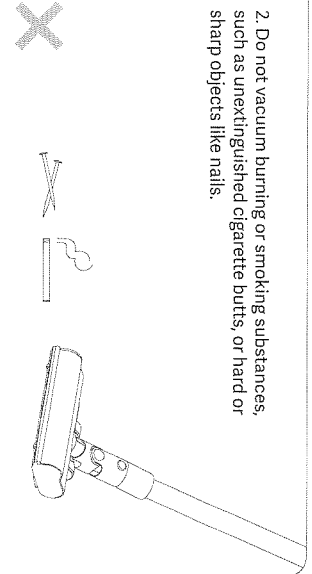

3. To prevent injury, do not touch rotating parts while the vacuum cleaner is running.

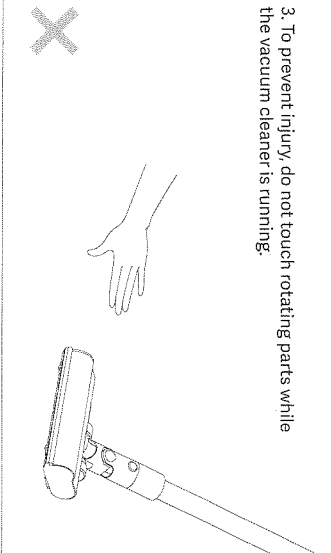

4. Do not charge or store the vacuum cleaner near heat sources or in humid areas, such as by a radiator or in a kitchen or bathroom.

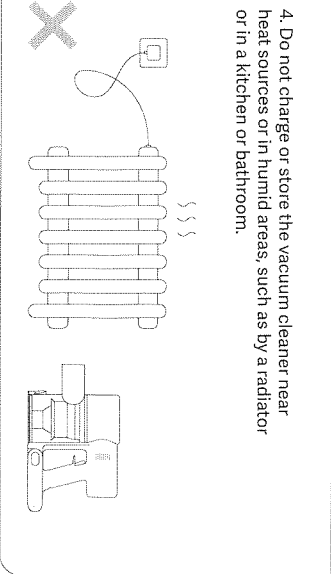

How to Install

Installing the Accessories onto the Vacuum Cleaner

Note: Mini electric brush should not be used with the extension rod.

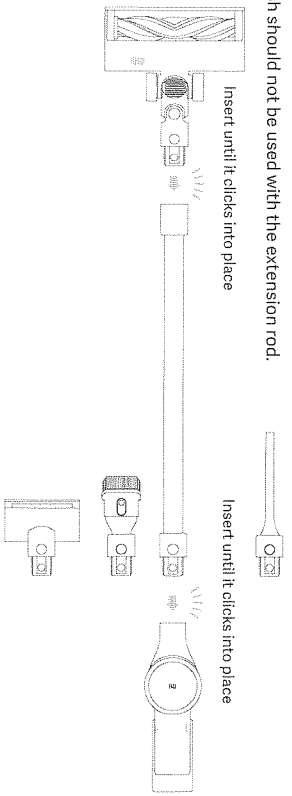

Charging

Fully charge the vacuum cleaner before turning it on for the first time and after each use. The total charging time is about 4 hours.

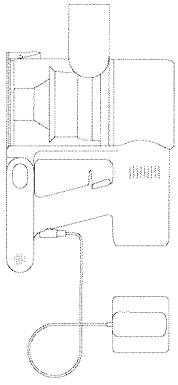

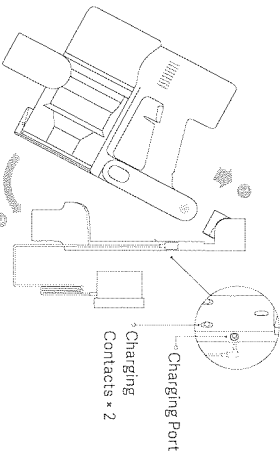

Charging the vacuum cleaner with the charger



Charging the vacuum cleaner on the charging mount

How to Use

Setting Language

Press and hold the button  for 3 seconds to open the language list, then press the button  to scroll through the language to select the desired one. Press and hold the button  for 2 seconds to use the selected language.

Note: The display screen will go off if there is no operation for more than 10 seconds.

Switching Suction Levels

Press the button  to switch suction levels of eco, standard/auto, and high power. The corresponding suction level will be highlighted on the display screen.

Only when using the smart high torque brush bar, the auto mode will be activated and the notification of "Auto" will appear on the display screen. The vacuum cleaner will then automatically switch the suction level between the floor/tile and the carpet.

Note: Stop the vacuum cleaner at any time while cleaning, and it will continue to use the last selected suction level when started again.



Working Modes

1. Non-continuous Mode

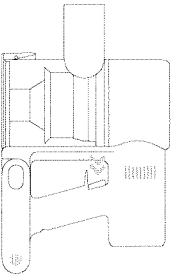
Hold down the power button to start the vacuum cleaner, then release to stop it.



2. Continuous Mode

Press the button  to enable Continuous Mode, then press the power button to turn the vacuum cleaner on. To exit Continuous Mode, press the button .

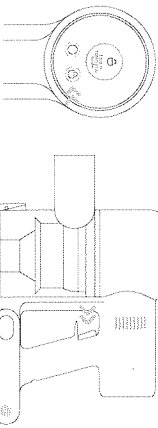

Notes:

- In Continuous Mode, the vacuum cleaner will enter into standby mode when pressing the power button, and resume running if pressing the button again.
- When the vacuum cleaner keeps in standby mode for more than 10 seconds, its display screen will go off and the vacuum cleaner will then exit the Continuous Mode.

Cleaning

Washable Parts

These parts must be separated from the vacuum cleaner or assembly prior to cleaning. Make sure the washed parts are thoroughly dry for at least 24 hours.



Crevice Nozzle

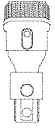

2-in-1 Brush Nozzle



Mini Roller Brush



Roller Brush



Dust Compartment

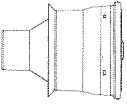

Cyclone Assembly



HEPA Filter



Pre-filter

Warning: Only the above parts are washable, the rests and the vacuum cleaner itself are non-washable.